

DISPLAY PRESSURE SWITCH

Swiss based Trafag is a leading international supplier of high quality sensors and monitoring instruments for measurement of pressure and temperature. The DPC 8381 is the ideal combination of pressure switch and transmitter with a pressure display. The parameters are set on the device or in a timesaving way via an NFC - smartphone App. The settings in combination with a comprehensive set of options make the DPS 8381 suitable for a wide range of demanding applications.

Applications

- Machine tools
- Hydraulics
- Process technology
- Industrial applications



Features

- Analogue output switchable mA or V
- 2 Switching outputs PNP
- Parametrisation also via NFC-smartphone App (Android)
- Threefold overpressure resistance, measuring principle thin film on steel
- Display and electrical connection are independently rotatable 335°/343°

Technical Data

Measuring principle	Thin film on steel	Media temperature	-25°C ... +85°C
Measuring range	0 ... 2.5 to 0 ... 600 bar 0 ... 30 to 0 ... 7500 psi adjustable 50 ... 100 % FS	Ambient temperature	-25°C ... +85°C
Output signal	4 ... 20 mA, 0 ... 5 VDC, 1 ... 6 VDC, 0 ... 10 VDC, switchable mA or V	Pressure unit for display	bar, psi, MPa, kPa, m WC, mm WC
Switching output	2 transistors PNP	Logger	Ring buffer: 3518 data points Sampling time: 0.1 ... 999.9 s, Off (0)
Accuracy @ 25°C typ.	± 0.5 % FS typ.		

04/2017

Data sheet H72321d

Subject to change

Ordering information/type code

				8381 . XX			XX	XX	XX	XX	XX
Measuring range ¹⁾	Pressure measurement range [bar]	Over pressure [bar]	Burst pressure [bar]	Pressure measurement range [psi]	Over pressure [psi]	Burst pressure [psi]					
	0 ... 2.5	7.5	50	0 ... 30	90	700	G5				
	0 ... 4	12	60	0 ... 50	150	850	G6				
	0 ... 6	18	100	0 ... 100	300	1450	G7				
	0 ... 10	30	200	0 ... 150	450	2500	G8				
	0 ... 16	48	200	0 ... 200	600	2500	GA				
	0 ... 25	75	300	0 ... 250	750	2500	G9				
	0 ... 40	120	300	0 ... 300	900	4000	HA				
	0 ... 60	180	400	0 ... 400	1200	4000	H0				
	0 ... 100	300	500	0 ... 500	1500	4000	H1				
	0 ... 160	480	750	0 ... 1000	3000	5000	H2				
	0 ... 250	750	1000	0 ... 1500	4500	7000	H3				
	0 ... 400	1000	2000	0 ... 2000	6000	10000	H5				
	0 ... 600	1500	2500	0 ... 3000	9000	14500	G4				
				0 ... 5000	12500	21750	H4				
				0 ... 7500	18750	29000	H6				
Sensor	Relative pressure, accuracy: 0.5 %							25			
Pressure connection	G1/4" female ²⁾	10	1/2" NPT male ²⁾	51							
	G1/4" male (Seal)	17	M14x1.5 male DIN6149-2 ²⁾	31							
	R1/4" male, DIN3858 ²⁾	19	7/16"-20UNF male, DIN3866 ^{2) 4)}	18							
	G1/2" male (Manometer) ²⁾	11	7/16"-20UNF male SAE4 (J1926) ^{2) 5)}	42							
	1/4" NPT male ²⁾	30	7/16"-20UNF female SAE J512 with valve opener ^{2) 4)}	24							
Electrical connection	Male electrical plug M12x1, 4-pole, Mat. PA (Accessories P3, P4)						32				
	Male electrical plug M12x1, 5-pole, Mat. PA (Accessories P1, P2)						35				
Output signal	Switching output PNP, current output 4 ... 20 mA; output detail see accessories P1, P2, P3										PA
	Switching output PNP, voltage output 1 ... 6 VDC; output detail see accessories P1, P2, P3										PU
	Switching output PNP, voltage output 0 ... 10 VDC; output detail see accessories P1, P2, P3										PV
	Switching output PNP, voltage output 0 ... 5 VDC; output detail see accessories P1, P2, P3										PW
	Switching output PNP; output detail see accessory P4										PS
Accessories	Pin configuration 5-pole.; 1: U+, 2: analogue, 3: U-, 4: SP1, 5: SP2										P1
	Pin configuration 5-pole.; 1: U+, 2: SP2, 3: U-, 4: SP1, 5: analogue										P2
	Pin configuration 4-pole.; 1: U+, 2: analogue, 3: U-, 4: SP1										P3
	Pin configuration 4-pole.; 1: U+, 2: SP2, 3: U-, 4: SP1										P4
	Pressure peak damping element ø 1.0 mm (for pressure connections 17 and 30)										40
	Pressure peak damping element ø 0.4 mm (for pressure connections 17 and 30)										44
	Seal FPM, -18°C ... +125°C										61
	Seal EPDM, -40°C ... +125°C										63
	Seal NBR, -25°C ... +100°C										83
	Female electrical plug M12x1, 5-pole ³⁾										33
	Parametrisation standard (see table Parameter)										ZS
	Parametrisation according to customer specifications (see table Parameter)										ZC

¹⁾ Extended overpressure as well as customized pressure ranges upon request

²⁾ Upon request

³⁾ For electrical connections 32 and 35

⁴⁾ Max. allowable pressure range 60 bar at 120 bar overpressure

⁵⁾ According to norm J1926, max. 35 MPa

Parameter				
Name	Standard setting (accessory ZS)	Value range	Short name	Customer adjustment (accessory ZC)
Switch point SP1 (hysteresis mode) Upper switch point FH1 (window mode)	75 % Measuring range	SP1 > RP1 FH1 > FL1 Hysteresis ≥ 1 % FS	SP1	
Reset point RP1 (hysteresis mode) Lower switch point FL1 (window mode)	25 % Measuring range	RP1 < SP1 FL1 < FH1 Hysteresis ≥ 1 % FS	RP1	
Switch point SP2 (hysteresis mode) Upper switch point FH2 (window mode)	75 % Measuring range	SP2 > RP2 FH2 > FL2 Hysteresis ≥ 1 % FS	SP2	
Reset point RP2 (hysteresis mode) Lower switch point FL2 (window mode)	25 % Measuring range	RP2 < SP2 FL2 < FH2 Hysteresis ≥ 1 % FS	RP2	
Switch point delay time SP1 (hysteresis mode) Switch point delay time FH1 (window mode)	0	0 ... 99.99 s	dS1	
Switch point delay time RP1 (hysteresis mode) Switch point delay time FL1 (window mode)	0	0 ... 99.99 s	dR1	
Switch point delay time SP2 (hysteresis mode) Switch point delay time FH2 (window mode)	0	0 ... 99.99 s	dS2	
Switch point delay time RP2 (hysteresis mode) Switch point delay time FL2 (window mode)	0	0 ... 99.99 s	dR2	
Functions switching output 1	Hysteresis, closer (Hno)	Hysteresis NO (Hno), Hysteresis NC (Hnc) Window NO (Fno), Window NC (Fnc)	ou1	
Functions switching output 2	Hysteresis, closer (Hno)	Hysteresis NO (Hno), Hysteresis NC (Hnc) Window NO (Fno), Window NC (Fnc)	ou2	
Pressure units	bar	bar, psi, MPa, kPa, m WC	uni	
Measuring range adjustment	100 % Nominal pressure	50 ... 100 % Nominal	P-EP	
Damping (analogue output)	0.01 s	0.01 ... 3.00 s (time constant)	dAA	
Display rotation	No	no, yes (180°)	disr	
Display mode	Current pressure value	Pressure value: current, highest, lowest, display off Current value: decimal places selectable (max. 3)	dis	
Display actualisation	2	1, 2, 5, 20 Hz	duPd	

Specifications		
Electrical Data	Output / supply voltage	4 ... 20 mA: 24 (15 ... 30) VDC 0 ... 5 VDC: 24 (15 ... 30) VDC 1 ... 6 VDC: 24 (15 ... 30) VDC 0 ... 10 VDC: 24 (15 ... 30) VDC
	Switch-on-delay	Typ. 200 ms
	Inverse-polarity protection, short-circuit strength @ 25°C during 5 min.	integrated
	Current consumption	≤ 30 mA
Environmental conditions	Media temperature	-25°C ... +85°C
	Ambient temperature	-25°C ... +85°C
	Protection ¹⁾	IP65
	Humidity	Max. 95 % relative
	Vibration	10 g (10 ... 2000 Hz)
	Shock	50 g / 3 ms
EMC Protection	Emission	EN/IEC 61000-6-3
	Immunity	EN/IEC 61000-6-2
Mechanical Data	Sensor (wetted parts)	1.4542 (AISI630)
	Pressure connection (wetted parts)	1.4542 (AISI630)
	Housing	Steel, die cast metal galvanised display housing plastic
	Sealing	FPM, NBR, EPDM
	Male electrical plug	See ordering information
	Weight	~ 189 g
	Mounting torque	15 ... 20 Nm
	Housing alignment	Display 335° rotatable, max. 2.5 Nm Electrical connection 343° rotatable, max. 5 Nm

¹⁾ See electrical connection

Measuring accuracy 0.5 %

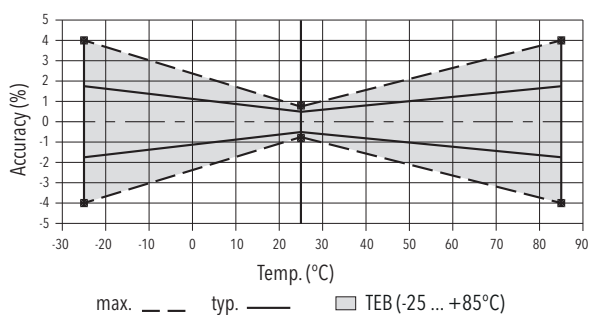

Analogue output

Output signal	Switchable 4 ... 20 mA or voltage		
Accuracy	TEB @ -25...+85°C	[% FS typ.]	± 1.75
	Accuracy @ +25°C	[% FS typ.]	± 0.5
	NLH @ +25°C (BSL)	[% FS typ.]	± 0.2
	TC zero point and span	[% FS/K typ.]	± 0.03
	Long term stability 1 year	[% FS typ.]	± 0.1
Current limiting output signal	4 ... 20 mA: 25 mA (overload)		
	0 ... 10 VDC: < 40 mA (short-circuit)		
Damping (rise time)	0.01 ... 3.00 s / 10 ... 90 % Nominal pressure		

Switching output

Accuracy	Accuracy @ +25°C	[% FS typ.]	± 0.5
	TEB @ -25...+85°C	[% FS typ.]	± 1.0
	Long term stability 1 year	[% FS typ.]	≤ ± 0.3
Adjustment range of switchpoints	0 ... 100 % FS		
Switching hysteresis	≥ 1 % FS		
	Switchpoint > reset point		
Switching resistance	≤ 3 Ω		
Output function	Hysteresis, Window; normally closed (NO), normally open (NC)		
Switching current	≤ 0.5 A each switching output		
Current limiting	≤ 2 A each switching output		
Switching frequency	max. 200 Hz		
Delay time	0 ... 99.99 s		

Display

Display	4-digit 7-segment display 180° flippable with disable function Standard decimal places: ≤ 9: 3 decimal places 10 ... 99: 2 decimal places 100 ... 999: 1 decimal place
Switching status indication	2 LED, red
Operation	With 3 buttons and menu navigation according to VDMA 24574-1
Display resolution	0.1 % FS
Display range	-3 ... 103 % FS
Setting parameters	See table Parameter

Dimensions

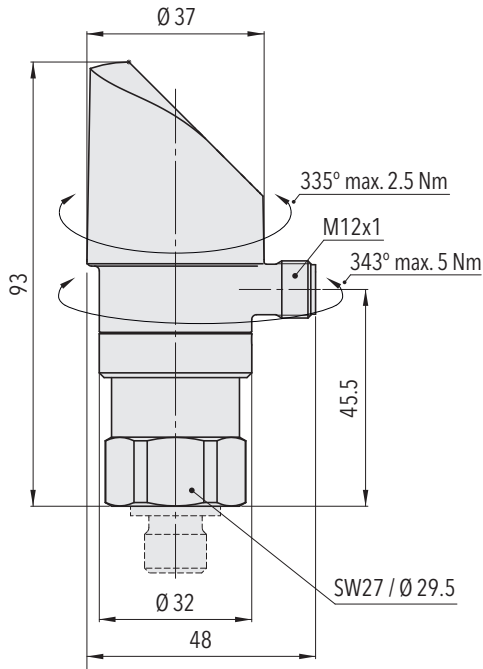

8381.XX.XXXX.35/32.XX.XX

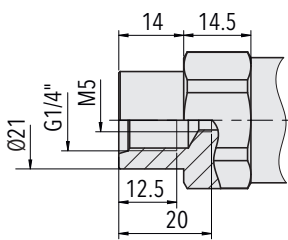

8381.XX.XX10.XX.XX.XX

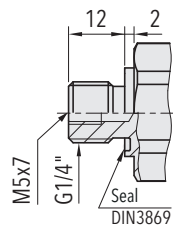

8381.XX.XX17.XX.XX.XX

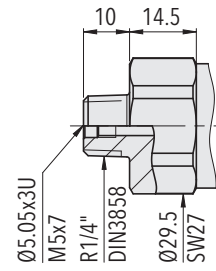

8381.XX.XX19.XX.XX.XX

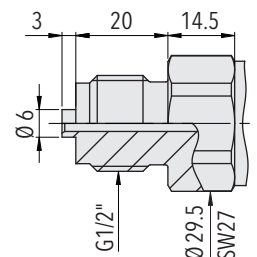

8381.XX.XX11.XX.XX.XX

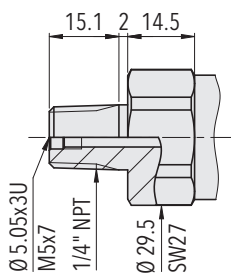

8381.XX.XX30.XX.XX.XX

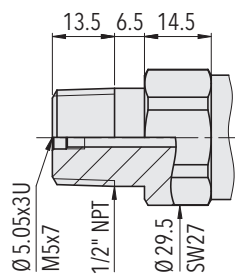

8381.XX.XX51.XX.XX.XX

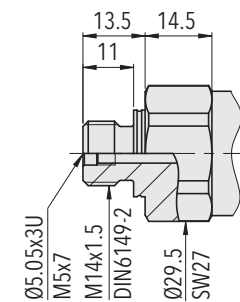

8381.XX.XX31.XX.XX.XX

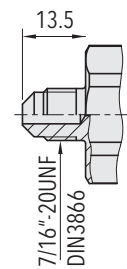

8381.XX.XX18.XX.XX.XX

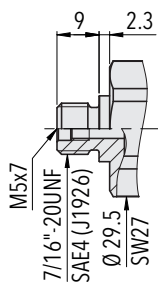

8381.XX.XX42.XX.XX.XX

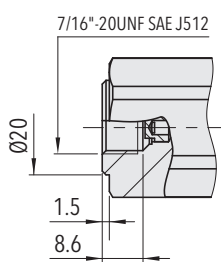

8381.XX.XX24.XX.XX.XX

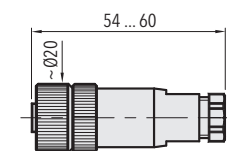

8381.XX.XXXX.XX.XX.33

Electrical connection

		Protection / electrical connection			
		IP65*)			
		M12x1			
		5-pole 35		4-pole 32	
Output signal		P1	P2	P3	P4
	PA	✓	✓	✓	
	PU	✓	✓	✓	
	PV	✓	✓	✓	
	PW	✓	✓	✓	
	PS				✓
Pin Configuration		P1	P2	P3	P4
	U _S + U _S - Out analogue SP1 SP2 Shield *** 8381..XX.XXXX.XX.PA/PU/PV/PW/PS	1 3 2 4 5 Shield *** Shield *** Shield ***	1 3 5 4 2 Shield *** Shield ***	1 3 2 4 Shield *** Shield ***	1 3 - 4 2 Shield *** Shield ***

Connection of loads to switching output

*) Provided female connector is mounted according to instructions

***) The use of a shielded cable is recommended

Functions switching output

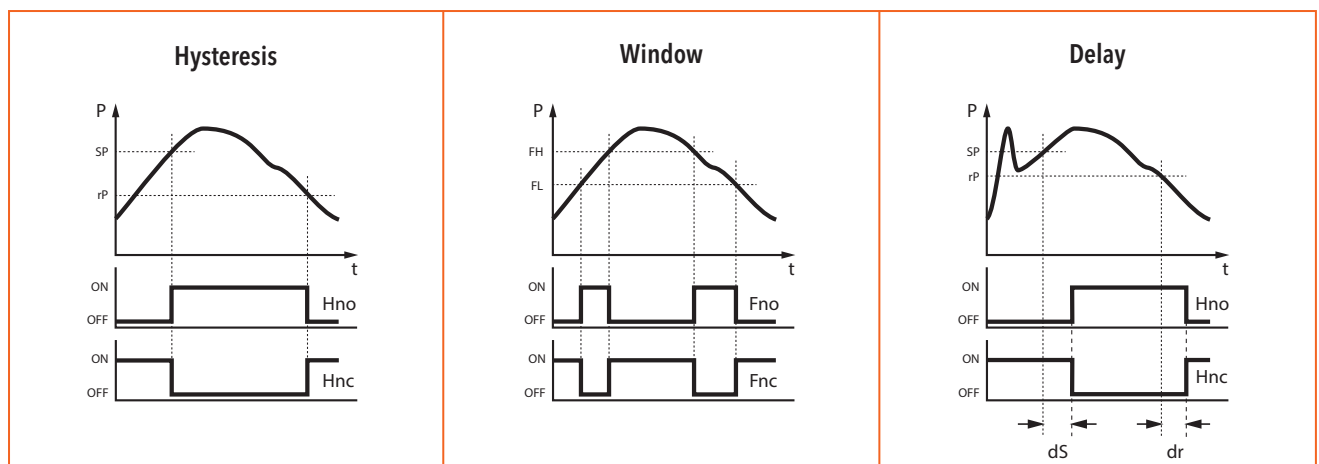

Additional information		
Documents	Data sheet	www.trafag.com/H72321
	Instructions	www.trafag.com/H73320
	Flyer	www.trafag.com/H70694