

Technical Datasheet

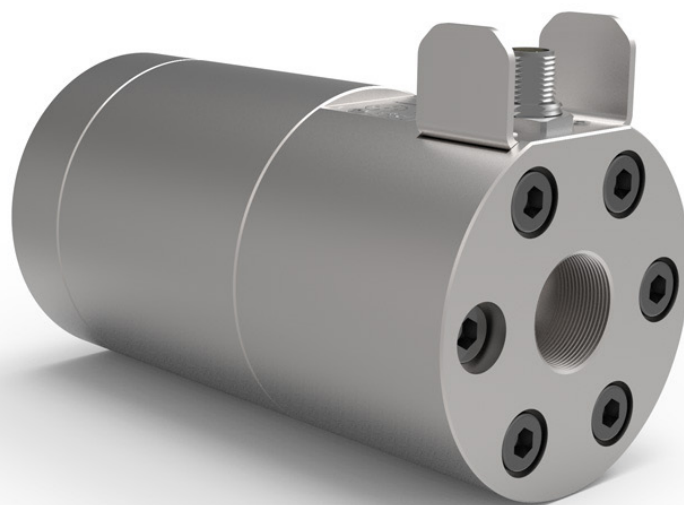

SRZ Compact Series

Helical Flow Meters
with integrated electronics

Overview

With more than 50 years of experience in the flow measurement field and numerous innovative and customer-specific product developments, we are a qualified and competent contact for flow measuring technology and calibration. KEM offers a broad selection of measuring principles for this purpose. We develop, produce, and deliver high quality Gear Flow Meters, Turbine Flow Meters, Helical Flow Meters and Micro Flow Meters as well as Coriolis Mass Flow Meters worldwide. Specific accessories complement the product range.

This document provides information, technical details and typical applications concerning the SRZ Compact Helical Flow Meter Series.

Series	Application	Process Medium	Attributes
SRZ ST	Flow measurement	Polymers, adhesives, silicone Abrasive, less lubricating Medium/high viscosity	Stainless steel body Tungsten carbide sleeve bearing Bigger tolerances
SRZ KL	Filling processes	Hydraulic fluids, glycol, grease Lubricating Medium/high viscosity	Stainless steel body Stainless steel ball bearing Bigger tolerances
SRZ Compact	Consumption measurement	Sealant, additives, fuels Abrasive, less lubricating Medium/high viscosity	Stainless steel body Tungsten carbide sleeve bearing Bigger tolerances
SRZ High Resolution	Dosage control (High Resolution)	Resin, lubricants, waxes Abrasive, less lubricating Medium/high viscosity	Stainless steel body Tungsten carbide sleeve bearing Bigger tolerances

Please contact KEM Sales for additional information on our Flow Meters or for advisory purposes related to your individual application needs. For KEM Sales contact details see the document's last page.



Description

The SRZ Compact helical flow meter series are flow-measuring devices that are used mainly in high-viscosity, abrasive, filled as well as lubrication and non-lubrication media. These include polyurethane, polymers and viscous products, as well as all kinds of greases and oils.

Only high-grade steels that even withstand corrosive liquids are used in the production of helical flow meters. Combined with the use of tungsten carbide bearings, the SRZ Compact guarantees optimum measurement accuracy and a long service life even under the toughest application conditions.

The SRZ Compact is intended for precise volume flow measurement in various media. These include adhesives, sealants, and polymers as well as all kinds of greases and oils. Temperature fluctuations and the resulting viscosity changes have only a very minor effect on the measuring accuracy. Key features of the helical flow meter are a broad measuring range, low shear, and low pressure loss at high viscosities.

Extremely high resolution, short response times, very dynamic performance and high measurement accuracy ensure accurate regulation and control of smallest dispensing volumes and flow rates in demanding applications.

Principle and Design

Two cycloidal helical spindles with geometrically lapped profiles that interlock with high precision lie in a cylindrical housing. This creates enclosed measuring chambers between the spindle profiles and the wall of the housing. These transport the medium being measured.

The medium is forcibly guided and flows through the measuring chamber bores in the axial direction, causing the spindles to rotate. This process is pulsation-free with minimum leakage. A contactless frequency measuring element with a high-speed pulse wheel captures the rotational speed of the spindle pair through the housing wall. The rotational speed of the spindles is exactly proportional to the volume flow over a very wide range. Appropriate electronic resolves the signal with nearly arbitrary precision. Impulses per unit of volume are available for the analysis.

The calibration factor of the Helical Flow Meter describes the exact pulse rate per unit of volume. In order to determine the individual calibration factor of a flow meter, each of our meters is internally calibrated by us prior to delivery. The operating viscosity specified by the customer is taken into account for calibration. A corresponding calibration certificate is included with every flow meter we supply.

Applications

- All types of adhesives
- Casting compounds and sealants
- Polyurethane and polymer
- Insulation materials and coatings
- Petrochemical products
- Different fats and oils with varying viscosities
- Light and heavy fuel oil

Features

- High measuring accuracy up to $\pm 0.1\%$ ¹⁾
- Exceptional repeatability of $\pm 0.05\%$
- Measuring range up to 1:100
- Short response times
- Pressure-resistant up to 250 bar [3,625 psi]
- Argely independent of viscosity, perfect for 1 to 1×10^6 mm²/s
- Low pressure drop compared with other positive displacement meters
- Pulsation-free measurement, non-sensitive to pulsating flows
- Resistant to corrosion by advanced materials and bearings

¹⁾ Under laboratory conditions; incl. linearization; viscosity ≥ 30 mm²/s in the measuring range of 1:100.

Technical Data – Sizes

SRZ Type ²⁾	Measuring Range (l/min)	K-Factor ³⁾ (pulses/l)	max. Pressure (bar/psi)	Frequency ³⁾ (Hz)	Weight (kg)
SRZ 40-*-A/C/R	0.4 to 40	7,000	250 [3,625]	44 to 4,700	6.2
SRZ 100-*-A/R	1.0 to 100	1,700	250 [3,625]	28 to 2,900	15.0
SRZ 400-*-A/R	4.0 to 400	428	250 [3,625]	28 to 2,900	34.0

Technical Data – General

Measuring Accuracy	Up to ± 0.1 % ⁴⁾
Repeatability	± 0.05 % (under the same conditions)
Linearity	± 0.5 % of actual flow (viscosity ≥ 30 mm ² /s) ± 0.25 % of actual flow (viscosity ≥ 100 mm ² /s)
Materials	Housing: as per DIN 1.4305 [AISI 303] Spindles: as per DIN 1.4122 Bearing: Tungsten carbide sleeve bearing Seals: FKM, PTFE (others on request)
Medium Temperature	-40 °C up to +70 °C [-40 °F up to +158 °F] (others on request)
Dimensions	See dimensional drawing (page 6)

²⁾ Exact type designation see ordering code (page 7).

³⁾ Average values (exact values: see customized calibration protocol).

⁴⁾ Under laboratory conditions; incl. linearization; viscosity ≥ 30 mm²/s in the measuring range of 1:100.

Technical Data – Electronics

Supply Voltage	12 to 30 V DC	
Supply Current	Typically < 20 mA without load	
Ingress Protection	IP67	
Plug	M12 plug-in connector (5-pin, male, A-coded)	
Output Stage	Pin 2, 4	Pin 5
Type	Push pull, asymmetrical output resistance 470/720 Ω	Push pull, 470 Ω output resistance
Max. Load Current	> 10 mA (typically up to 20 mA)	> 10 mA (typically up to 20 mA)
Output Level Low	1 V @ 1 mA 5 V @ 10 mA	1 V @ 1 mA 5 V @ 10mA
Output Level High	22 V @ 1 mA load and 24 V supply 16 V @ 10 mA load and 24 V supply	22 V @ 1 mA load and 24 V supply 19 V @ 10 mA load and 24 V supply
Output Short Circuit	To GND: infinite To + U _B < 1 s	To GND or to +U _B : < 1 s

Pin assignment

SRZ Type ⁵⁾	Pin 1	Pin 2	Pin 3	Pin 4	Pin 5
SRZ-*A	+ U _B	½ f _A	GND	f	½ f _B ⁷⁾
SRZ-*R	+ U _B	direction ⁶⁾	GND	f	n.c.
SRZ-*C	+ U _B	n. c.	GND	f	PE ⁸⁾

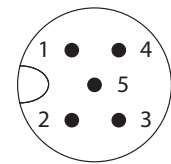

M12 plug-in connector
(5-pin, male, A-coded)

⁵⁾ Exact type designation see ordering code (page 7).

⁶⁾ At flow in direction of the arrow level at output is "high".

⁷⁾ At flow in direction of the arrow f_B advances f_A by 90°.

⁸⁾ The protective ground at pin 5 must only be used additionally to a proper grounding of the housing.

Dimensional Drawing

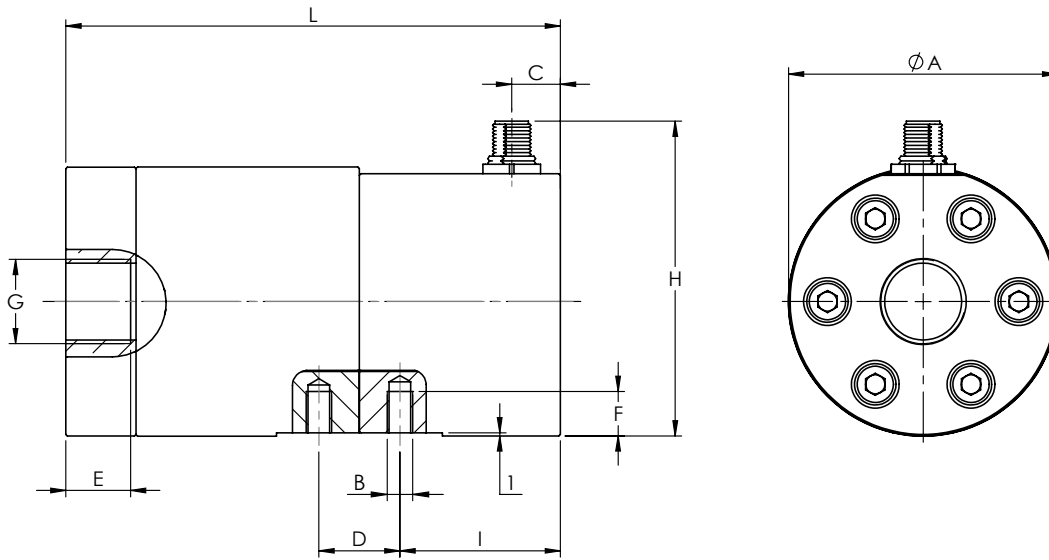

SRZ Type	Ø A	B	C	D	E	F	G ⁹⁾	H	I	L
SRZ 40	3.35 in [85 mm]	M8	0.59 in [15 mm]	0.98 in [25 mm]	0.75 in [19 mm]	0.51 in [13 mm]	G ¾" ¾" NPT	3.91 in [100 mm]	2.00 in [50 mm]	6.10 in [155 mm]
SRZ 100	4.29 [109 mm]	M10	0.87 in [22 mm]	1.73 in [44 mm]	0.83 in [21 mm]	0.75 in [19 mm]	G 1" 1" NPT	4.92 in [125 mm]	2.56 in [65 mm]	8.70 in [221 mm]
SRZ 400	5.28 in [134 mm]	—	1.65 in [42 mm]	—	1.06 in [27 mm]	—	G 1½" 1½" NPT	5.87 in [149 mm]	—	12.52 in [318 mm]

⁹⁾ Others on request.

Pressure Drop Curves

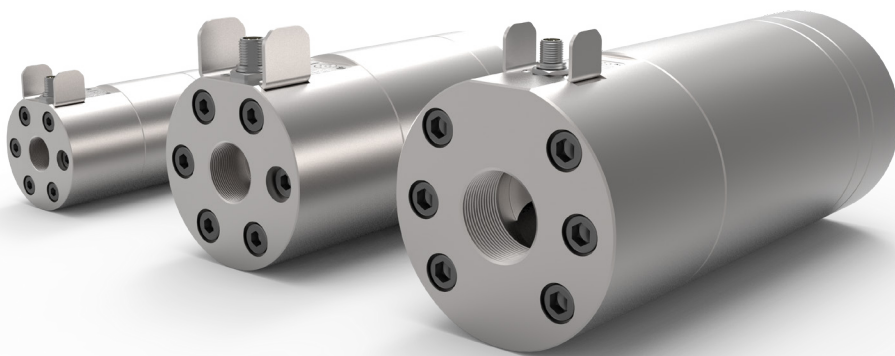
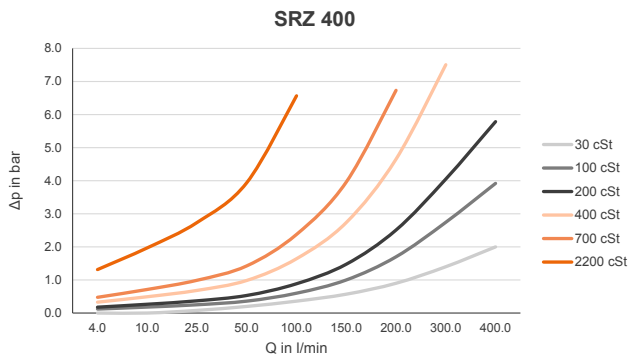
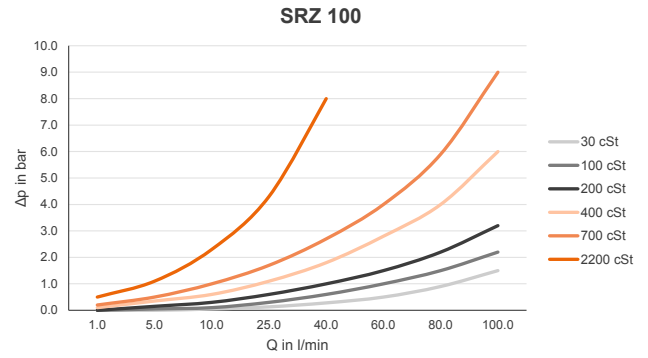
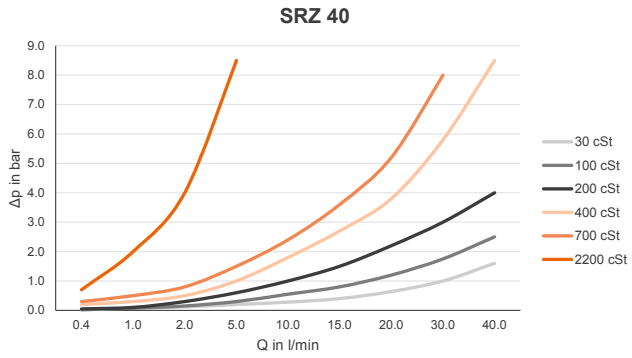

Calibration

In-house calibration is performed on volumetric calibration rigs or at the wishes of the customer in our DAkkS calibration laboratory.

The KEM calibration lab uses a high-precision load cell system. With an accuracy of 0.05 % for the mass and 0.1 % for the volume of flowing liquids, we occupy a leading position worldwide. The German Accreditation Body (DAkkS) has accredited the laboratory with engineers, processes and measuring equipment in accordance with the international standard DIN EN ISO/IEC 17025:2005.

The KEM calibration certificate not only verifies the accuracy of a flow meter, but also guarantees its traceability to national standards as well as ensuring all requirements according to international quality standards are met.

The calibrations are performed with different hydrocarbons. This ensures the optimum simulation of changing operating conditions in density and viscosity even when temperatures change. This way the primary viscosity for the use of the flow meter can be specifically taken into account when viscosity fluctuations occur in a customised application.

The calibration result is the specified calibration factor (K-factor) in pulses per litre. This K-factor accordingly applies only at a certain flow velocity or a certain flow rate.

The calibration factor varies only very slightly at different volume flow rates. The individual measuring points provide the calibration curve of the flow meter from which the average K-factor is determined. The average calibration factor applies to the entire measuring range.

The linearity error specification (percentage deviation) refers to the average K-factor. To further increase the measurement accuracy in onsite use, the specific K-factors can be used to calculate the flow rate. For this, KEM also supplies optional special electronics.

Calculation of volume flow

The flow is directly dependent on the measured frequency and the associated calibration factor:

$$Q = \frac{f \cdot 60}{K} \text{ l/min}$$

- Q = Volume Flow
- f = Measuring frequency
- K = Specific K-Factor

Calibration protocol

Example: SRZ 40 ST

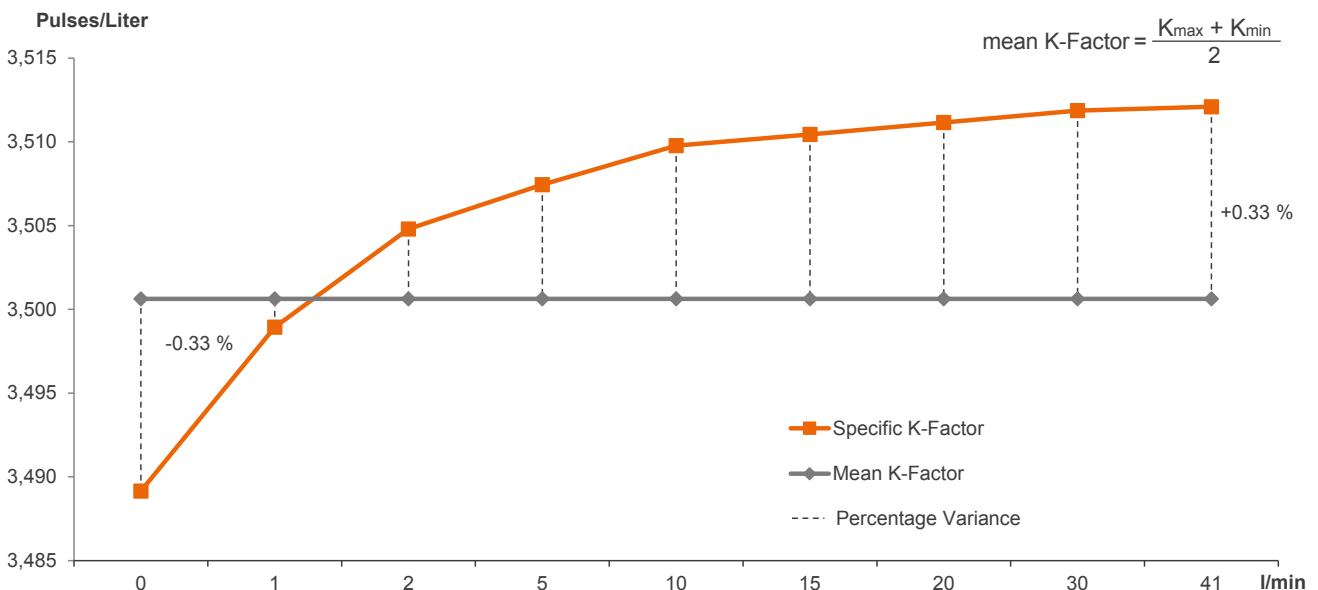



Küppers Elektromechanik GmbH

www.kem-kueppers.com

info@kem-kueppers.com

KEM Headquarters

Liebigstraße 5
85757 Karlsfeld
Germany

T. +49 8131 59391-0
F. +49 8131 92604

info@kem-kueppers.com

KEM Sales

Liebigstraße 5
85757 Karlsfeld
Germany

T. +49 8131 59391-100
F. +49 8131 92604

sales@kem-kueppers.com

KEM Manufacturing Center

Wetzeller Straße 22
93444 Bad Kötzing
Germany

T. +49 9941 9423-0
F. +49 9941 9423-23

production@kem-kueppers.com

KEM Service & Repairs

Wetzeller Straße 22
93444 Bad Kötzing
Germany

T. +49 9941 9423-37
F. +49 9941 9423-24

service@kem-kueppers.com

*More distributors & partners can be found at:
www.kem-kueppers.com*