

Technical Datasheet

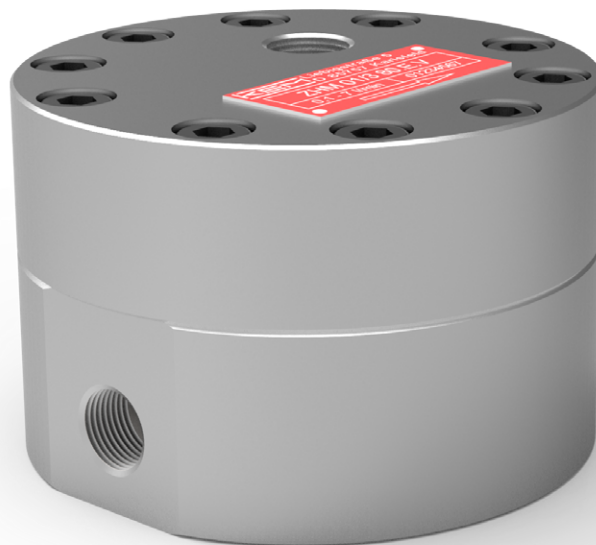

ZHM MK Series

Gear Flow Meter with ball bearing
for low viscous, lubricating fluids

Overview

With more than 50 years of experience in the flow measurement field and numerous innovative and customer-specific product developments, we are a qualified and competent contact for flow measuring technology and calibration. KEM offers a broad selection of measuring principles for this purpose. We develop, produce, and deliver high quality Gear Flow Meters, Turbine Flow Meters, Helical Flow Meters and Micro Flow Meters as well as Coriolis Mass Flow Meters worldwide. Specific accessories complement the product range.

This document provides information, technical details and typical applications concerning the ZHM MK Gear Flow Meter Series.

Series	Application	Process Medium	Attributes
ZHM ST	Flow measurement	Polyol + isocyanat, glue, epoxy resins Abrasive, less lubricating Medium/high viscosity	Stainless steel body Tungsten carbide sleeve bearing Bigger tolerances
ZHM KL	Filling processes	Lubricants, oils, grease Lubricating Medium/high viscosity	Stainless steel body Stainless steel ball bearing Bigger tolerances
ZHM MK	Dosing & consumption	Diesel, Skydrol, AdBlue, odorant (Less) lubricating Low viscosity	Stainless steel body Stainless steel ball bearing Small tolerances
ZHA KL	Test bed monitoring (Hydraulics)	Hydraulic fluid, ATF Lubricating Medium viscosity	Aluminum body Stainless steel ball bearing Bigger tolerances
ZHM CT	Dosage control (Paint shops)	Paints, waxes, amine Less lubricating Medium viscosity	Stainless steel body Tungsten carbide sleeve bearing Ball bearing (optional)
ZHM HP	Flow measurement (High Pressure)	Lubricants, coolant, inhibitors Abrasive, less lubricating Medium/high viscosity	Stainless steel body Stainless steel ball bearing Tungsten carbide sleeve bearing (optional)
ZHM CI	Dosage control (Oil & Gas)	Inhibitors, glycol, hydraulic control fluids Abrasive, less lubricating Low/medium viscosity	Stainless steel body Stainless steel ball bearing Tungsten carbide sleeve bearing (optional)

Please contact KEM Sales for additional information on our Flow Meters or for advisory purposes related to your individual application needs. For KEM Sales contact details see the document's last page.



Description

The ZHM MK gear flow meter (ball bearing design) are flow meters which are mainly used in lubrication and non-viscous liquids. Therefore they are used especially for the fuel consumption measurement and the dosing of low viscous media.

Only high-grade steels that even withstand corrosive liquids are used in the production of gear flow meters. Combined with the use of high-quality precision ball bearings, the ZHM MK guarantees optimum measurement accuracy and a long service life under even the toughest application conditions. The ball bearing facilitates a very low starting torque of the measuring element. This way even the lowest flow rates can be accurately measured.

Short response times, very dynamic performance and high measurement accuracy ensure accurate regulation and control of flow rates in demanding applications.

For applications in hazardous areas, we offer intrinsically safe sensors and amplifiers with Ex protection in accordance with ATEX, IECEx, CSA and other standards. Additional certifications such as EAC (TR-CU) are available.

Principle and Design

Gear flow meters (ZHM) are positive displacement meters. Two precise gears rotate freely inside the measuring chamber.

Sealed cavities are created between the gears and the housing. The measured media causes the rotation of the gears. The flowing medium is distributed evenly in the measuring chamber and causes the rotation of the gears. The gear wheels rotate freely and undamped in the media flow. Their rotational frequency is proportional to the flow rate and is measured by non-intrusive sensors (pickups) through the housing wall.

The sensor system can be variably adjusted to meet the requirements of the application. This allows, for example, providing even very high resolutions or also a signal for determining the direction of flow.

Pulses per unit of volume are available for analysis. The calibration factor (K-factor) of the flow meter describes the exact pulse rate per unit of volume. In order to determine the individual calibration factor of a flow meter, we calibrate each of our meters in house prior to delivery. The operating viscosity specified by the customer is taken into account for calibration. A corresponding calibration certificate is included with every flow meter we supply.

Thanks to a high output frequency, excellent resolution and short response times, our gear flow meters are outstanding for measuring pulsing flows, for consumption measurement and for dosing of liquids.

Applications

- Diesel- and fuel consumption
- Additive dosage
- Leakage measurement
- Odorization
- Laboratory and test bench applications

Features

- Measuring range from 0.002 l/min up to 70 l/min
- High measuring accuracy up to $\pm 0.1\%$ ¹⁾
- Exceptional repeatability of $\pm 0.05\%$
- Measuring range up to 1:500
- High resolution and short response time
- Pressure-resistant up to 630 bar (9,135 psi)
- Robust construction and long lifetime
- Explosion protection EExIICT4 or T6 for Zone 1

¹⁾ Under laboratory conditions; incl. linearization; viscosity ≥ 5 mm²/s and volume flow $\geq 2\%$ of the max. nominal flow.

Technical Data – Sizes

ZHM Type ²⁾	Measuring Range (l/min)		K-Factor ³⁾ (pulses/l)	max. Pressure (bar/psi)	Frequency ³⁾ (Hz)		Weight (kg)
ZHM 01/3	0.002	to 1.0	41,000	345 (5,000)	1.3	to 660	2.2
ZHM 01/2	0.02	to 3.0	14,000	630 (9,135)	4.6	to 700	1.6
ZHM 02	0.1	to 7.0	4,200	630 (9,135)	7	to 490	2.2
ZHM 03	0.5	to 25.0	1,740	630 (9,135)	14	to 730	2.9
ZHM 04	0.5	to 70.0	475	630 (9,135)	4	to 560	8.5

Technical Data – General

Measuring Accuracy	Up to ± 0.1 % ⁴⁾
Repeatability	± 0.05 % (under the same conditions)
Linearity	± 1.5 % of actual flow (viscosity ≥ 5 mm ² /s) ± 2.5 % of actual flow (viscosity ≥ 5 mm ² /s for ZHM 01/3)
Materials	Housing: as per DIN 1.4305 (AISI 303), 1.4404 (AISI 316L) Gears: as per DIN 1.4122 Bearing: Stainless steel ball bearing Seals: FKM, PTFE (others on request)
Medium Temperature	-40 °C up to +180 °C (-40 °F up to +356 °F)
Dimensions	See dimensional drawing (page 5)

Technical Data – Filter Element (optional for ZHM 01/3)

Type	SS-6F-MM15
Mounting position	Horizontal/vertical
Max. Pressure	Max. 200 bar/2,900 psi (at +37 °C/+98 °F) Max. 160 bar/2,320 psi (at +120 °C/+248 °F)
Material	As per DIN 1.4401 (AISI 316)
Mesh	15 μ m
Pressure Drop	Approx. 300 mbar (at 0.5 l/min and 2 mm ² /s)
Installation Length	Approx. 80 mm/SW 19
Connection	6 mm tube

²⁾ Exact type designation see ordering code (page 6)

³⁾ Average values for single sensors, dual pickups and higher resolution available.

⁴⁾ Under laboratory conditions; incl. linearization; viscosity ≥ 5 mm²/s and volume flow ≥ 2 % of the max. nominal flow.

Dimensional Drawing - ZHM 01/3 to 04

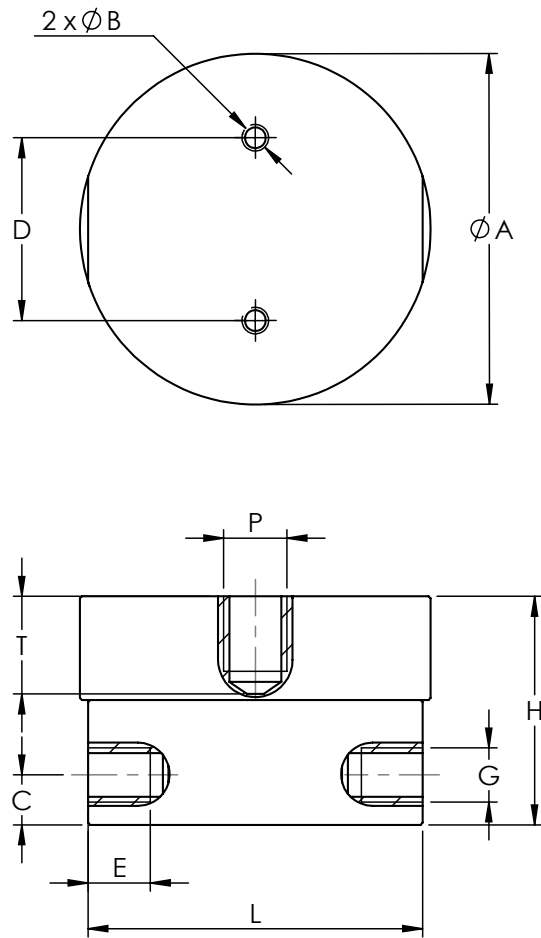

ZHM Type	Ø A	B	C	D	E	G ⁵⁾	H	L	P ⁶⁾	T ⁶⁾
ZHM 01/3	84.4 mm (3.32 in)	M6 ∇ 10	12 mm (0.47 in)	44 mm (1.73 in)	14 mm (0.55 in)	G ¼" ¼" NPT	55 mm (2.17 in)	80.5 mm (3.17 in)	E/D	24.4 mm (0.96 in)
ZHM 01/2	76 mm (2.99 in)	M6 ∇ 10	12 mm (0.47 in)	44 mm (1.73 in)	14 mm (0.55 in)	G ¼" ¼" NPT	50 mm (1.97 in)	72 mm (2.83 in)	E/D	18 mm (0.71 in)
ZHM 02	84.4 mm (3.32 in)	M6 ∇ 10	12 mm (0.47 in)	44 mm (1.73 in)	14 mm (0.55 in)	G ¼" ¼" NPT	55 mm (2.17 in)	80.5 mm (3.17 in)	E/D	23.5 mm (0.93 in)
ZHM 03	84.4 mm (3.32 in)	M6 ∇ 10	12 mm (0.47 in)	44 mm (1.73 in)	14 mm (0.55 in)	G ¼" ¼" NPT	67 mm (2.64 in)	80.5 mm (3.17 in)	E/D	23.5 mm (0.93 in)
ZHM 04	125 mm (4.92 in)	M6 ∇ 10	17 mm (0.67 in)	60 mm (2.36 in)	18 mm (0.71 in)	G ½" ½" NPT	96 mm (3.78 in)	121 mm (4.76 in)	E/D	30.5 mm (1.20 in)

⁵⁾ Only applies for single pickup holes of type „E“. Attention: the total installation height is the result of the height (H) and the height of the electronics (dimensions in separate datasheet).

Ordering Code

ZHM - XX - XX - X - X

Measuring Range

0.002 - 1.0 l/min	01/3
0.02 - 3.0 l/min	01/2
0.1 - 7.0 l/min	02
0.5 - 25 l/min	03
0.5 - 70 l/min	04

Meter Attributes

Housing	Gears	Bearing	Bolts	Thread	
1.4305 (AISI 303)	1.4122	ball bearing	ISO 4762	BSPP	81
1.4305 (AISI 303)	1.4122	ball bearing	ISO 4762	NPT	A6
1.4404 (AISI 316L)	1.4122	ball bearing	AISI 316 ⁶⁾	BSPP	A7
1.4404 (AISI 316L)	1.4122	ball bearing	AISI 316 ⁶⁾	NPT	80

Sensor Ports

M14x1.5	E
Plug-in (frequency doubling, bidirectional measurement)	D

Sealing Options

FKM (Viton [®])	V
PTFE (Teflon [®]) ⁶⁾	T



⁶⁾ P_{max.} 400 bar (5,800 psi).

Pressure Drop Curves

ZHM 01/3

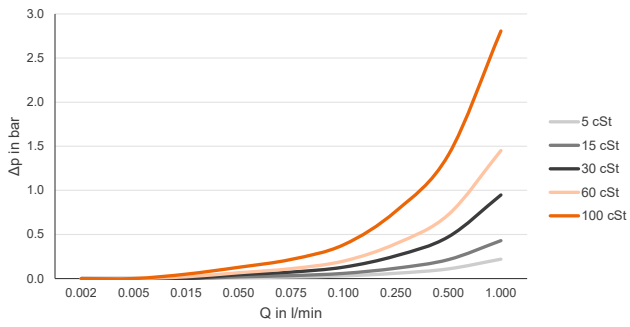

ZHM 01/2

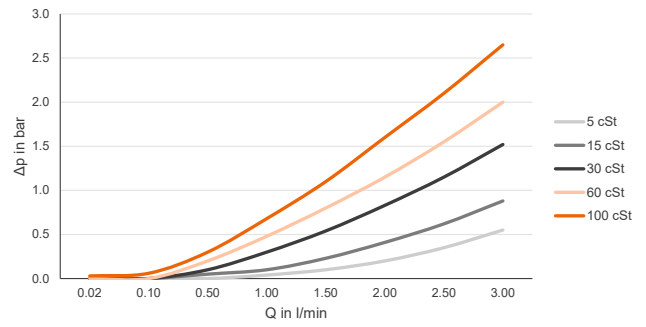

ZHM 02

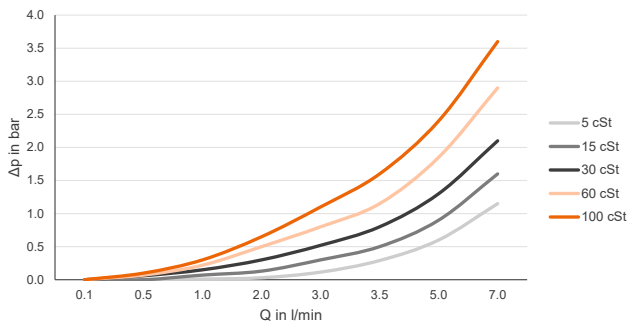

ZHM 03

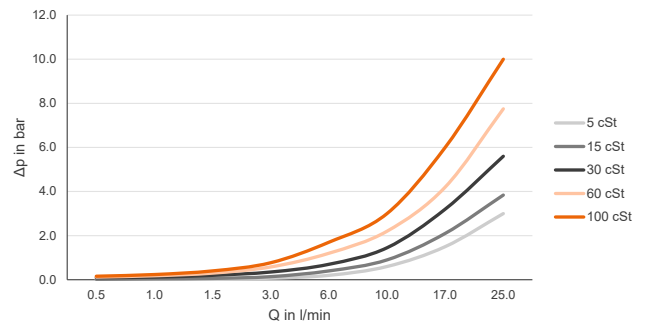

ZHM 04

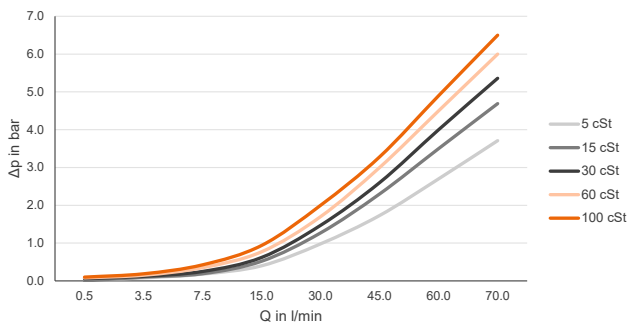

Calibration

In-house calibration is performed on volumetric calibration rigs or at the wishes of the customer in our DAkkS calibration laboratory.

The KEM calibration lab uses a high-precision load cell system. With an accuracy of 0.05 % for the mass and 0.1 % for the volume of flowing liquids, we occupy a leading position worldwide. The German Accreditation Body (DAkkS) has accredited the laboratory with engineers, processes and measuring equipment in accordance with the international standard DIN EN ISO/IEC 17025:2005.

The KEM calibration certificate not only verifies the accuracy of a flow meter, but also guarantees its traceability to national standards as well as ensuring all requirements according to international quality standards are met.

The calibrations are performed with different hydrocarbons. This ensures the optimum simulation of changing operating conditions in density and viscosity even when temperatures change. This way the primary viscosity for the use of the flow meter can be specifically taken into account when viscosity fluctuations occur in a customised application.

The calibration result is the specified calibration factor (K-factor) in pulses per litre. This K-factor accordingly applies only at a certain flow velocity or a certain flow rate.

The calibration factor varies only very slightly at different volume flow rates. The individual measuring points provide the calibration curve of the flow meter from which the average K-factor is determined. The average calibration factor applies to the entire measuring range.

The linearity error specification (percentage deviation) refers to the average K-factor. To further increase the measurement accuracy in onsite use, the specific K-factors can be used to calculate the flow rate. For this, KEM also supplies optional special electronics.

Calculation of volume flow

The flow is directly dependent on the measured frequency and the associated calibration factor:

$$Q = \frac{f \cdot 60}{K} \text{ l/min}$$

Q = Volume Flow
f = Measuring frequency
K = Specific K-Factor

Calibration protocol

Example: ZHM 01/3

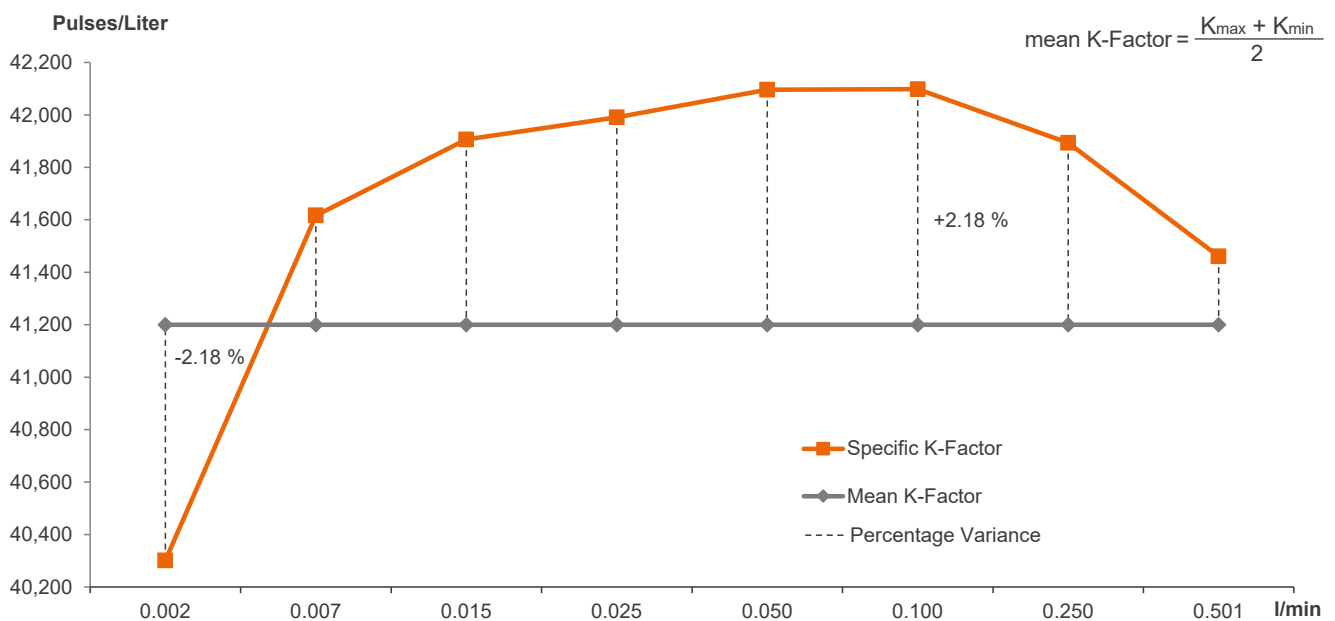



Küppers Elektromechanik GmbH

www.kem-kueppers.com

info@kem-kueppers.com

KEM Headquarters

Liebigstraße 5
85757 Karlsfeld
Germany

T. +49 8131 59391-0
F. +49 8131 92604

info@kem-kueppers.com

KEM Sales

Liebigstraße 5
85757 Karlsfeld
Germany

T. +49 8131 59391-100
F. +49 8131 92604

sales@kem-kueppers.com

KEM Manufacturing Center

Wetzeller Straße 22
93444 Bad Kötzing
Germany

T. +49 9941 9423-0
F. +49 9941 9423-23

production@kem-kueppers.com

KEM Service & Repairs

Wetzeller Straße 22
93444 Bad Kötzing
Germany

T. +49 9941 9423-37
F. +49 9941 9423-24

service@kem-kueppers.com

*More distributors & partners can be found at:
www.kem-kueppers.com*